

Varenummer: 025849160076  
Beskrivelse: Norma Connect rørkobling  
COMBI GRIP GL W2 Ø76,1/75 EPDM 16 bar

## Mål

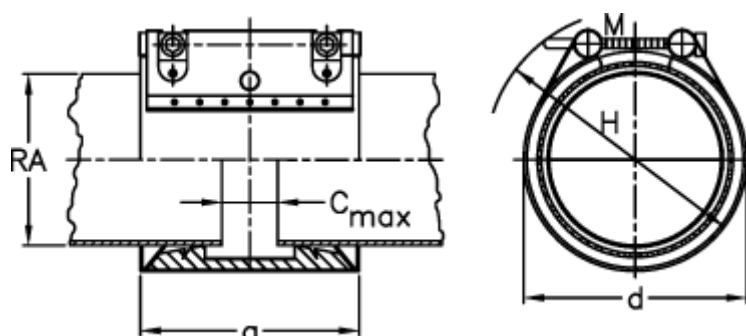

a	= 98.0	RA min-RA max metal = 75,0-76,9
C max med båndindlæg	= 25	Vægt pr stk. = 1.5
d	= 95	
H	= 115	
M (Skrue)	= M10	
Nominelt tryk (bar)	= 16	
RA	= 76,1/75,0	
RA min-RA max kunststof	= 74,0-76,0	